



FEBRUARY  
2025



Roofing Products

A Division of **MACSTEEL**

PRODUCT BROCHURE

# ROOFING INNOVATION



Harvey Elite® Midnight Black



Harvey Elite Plus® Burgundy



Harvey Thatch Greystone®



Harvey EcoTile®



Look for the Harveytile Quality Stamp ▶▶





# Harvey Roofing Products

Selecting the right building product is a crucial decision. You need a solution that is reliable, durable, and trusted for its performance.

With almost 60 years of proven excellence, Harvey Roofing Products offers a reputable and time-tested roofing solution that meets the highest standards for quality and longevity.

**Strong Foundations**  
The same strict code of professionalism, quality and service has placed Harvey Roofing Products at the top of the steel roofing business, and our reputation has been steadily extended through the obvious satisfaction of Specifiers, Builders and Homeowners alike.

**Strong On Looks**  
Harvey Roofing Products manufactures several roofing systems. Our range of roof tiles offer superb structural integrity and immaculate appearance. Our world-class factory based in Brakpan, South Africa, is one of the largest of its kind in the world and maintains high quality standards.

**Strong In Design**  
Each tile is designed and manufactured for strength. The unique overlapping system and fixing technique provide not only a leakproof roof but is also burglar resistant. Steel tiles are also available in Alu-Zinc coated steel for added long term corrosion resistance. Harvey EcoTile is a mineral polymer that will not corrode.

**Durable**  
Through decades of on-going research and development, the stone coating on our steel based tiles will withstand high ultra-violet levels and most adverse weather conditions. The small stone granules bonded to the tile surface result in a durable finish which protects against extensive weathering such as gale force winds, pelting rain and hailstorms.

**Low on Maintenance**  
A Harveytile roof is low on maintenance, which means you don't have the inconvenience of fixing leaks or replacing broken tiles. Stone coated tiles will not require any overpainting.

**Versatile**  
Harveytiles are also ideal for re-roofing, easily transforming your house into a prize home in a short space of time.

**Strong On Savings**  
The excellent weight-to-strength ratio means that, with our tiles, you invest your money in the tiles and not in costly roof structures.

**Weatherproof**  
Both the steel-based tiles and mineral polymer EcoTile can withstand the harshest elements.

**20 Year Warranty**  
Harvey Roof Tiles has excellent functional benefits, offering a 20 year Product Warranty (Terms & Conditions apply).



# Harvey Roofing Product Range



**Harvey Elite**



**Harvey Elite PLUS**



**Harvey Thatch**

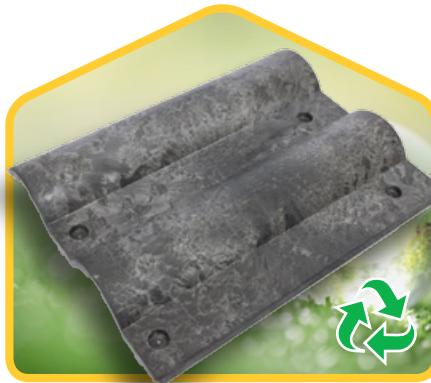

**Harvey EcoTile**



**Harvey Solar Bracket**

### Bracket Specification

The Harvey Solar bracket is suitable for the application of solar panels and geysers. Manufactured from high tensile steel, there is no need to pierce the Harvey Roof Tile and risk a leaking roof. The Harvey Solar Bracket is easily fitted onto the timber or steel batten. Uniform Wind Uplift: 2Kn/m<sup>2</sup>

## Profiles

### Harvey Elite

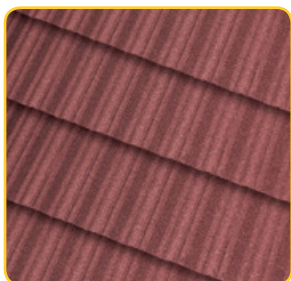

(Approx.)  
 Overall Length: 1675 mm  
 Cover: 1600 mm  
 Overall Width: 397 mm  
 Cover: 369 mm  
 Mass per tile: 3.3 kg  
 Mass per sq. metre: 5.6 kg  
 No. of tiles per sq. metre: 1.69

### Harvey Elite Plus

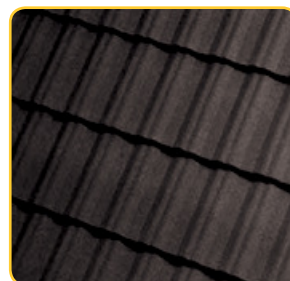

**Tile Specification** (Approx.)  
 Overall Length: 1675 mm  
 Cover: 1600 mm  
 Overall Width: 397 mm  
 Cover: 369 mm  
 Mass per tile: 3.9 kg  
 Mass per sq. metre: 6.6 kg  
 No. of tiles per sq. metre: 1.69

### Harvey Thatch

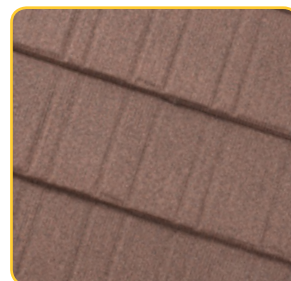

**Tile Specification**  
 Overall Length: 1675 mm  
 Cover: 1 625 mm  
 Overall Width: 395 mm  
 Cover: 350 mm  
 Mass per tile: 4.2 kg  
 Mass per sq. metre: 6.9 kg  
 No. of tiles per sq. metre: 1.76

### Double Roman EcoTile



**Tile Specification**  
 Overall Length: 420 mm  
 Cover: 335 mm  
 Overall Width: 324 mm  
 Cover: 310 mm  
 Mass per tile (ave): 1.6 kg  
 Mass per sq. metre: 15.36 kg  
 No. of tiles per sq. metre: 9.6



# Product Range Standard Colours



Midnight Black



Burgundy



Green



Terracotta

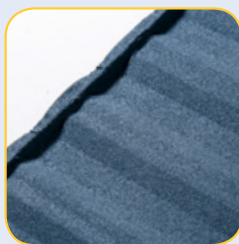

Dark Blue



Midnight Black



Greystone



Burgundy



Green



Terracotta



Dark Blue



Thatch Dark



Thatch Light



Thatch Greystone



Thatch  
Midnight Black



Marbled Black

The  
**Affordable**  
Quality  
Guaranteed  
Steel Roof Tile



## Harvey Elite: Lightweight Strength with Timeless Style.

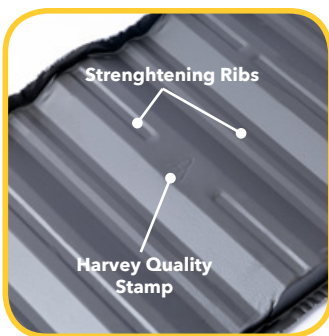

Your home is one of your most significant investments, and a Harvey Roof ensures it's protected. Safeguard your loved ones, cherished possessions, and the value of your home with the trusted quality and elegance of Harvey Elite Roof Tiles.

Lightweight, leakproof and weatherproof, Harvey Elite Roof Tiles not only look good, it reduces long-term maintenance and cost on your roof structure. Harvey Elite's strength lies in the use of high grade materials and unique Strengthening Rib design.

With Harvey Elite, you get more than a roof – you get peace of mind, lasting beauty, and exceptional value.



### Super Lightweight

- Lightweight steel-based roof tiles
- Save on roof-structure timber costs
- Ideal for new roof or re-roofing old roofs



### Weatherproof

- Gaps are eliminated
- Wind proof
- Hail proof
- Water and leakproof
- Minimised dust ingress
- No water absorption



### Low Maintenance

- Avoid the inconvenience of fixing leaks
- Tiles do not need replacement



### Attractive

- A range of stunning standard colours
- Double roman design for a unique roof appearance
- Ridge, cap and trim accessories for a professional finish



### Unbreakable

- Unbreakable steel substrate
- Bonded stone granules protects against the elements
- No more broken roof tiles even in hailstorms



### Solar Compatible

- Fixing brackets available
- A steel drill bit can easily be used for drilling holes for wiring / piping requirements



### Easy to Install

- Easily installed on new roofs or over existing roof
- Engineered for effortless overlapping and fixing
- Lightweight for handling and on-site speed



### Important

When walking on Harvey Tiles, always wear grippy, soft-soled work footwear. Step sideways along the bottom centre as this is supported by the battens, or try to step on two tiles at once.... It is important that you distribute your weight evenly and keep your centre of gravity. Do not step into the "pan" of the tile.



The  
**Original**  
Steel Roof Tile  
Since 1967



**The original Harveytile with its legendary strength and good looks.**

Since 1967, Harvey Elite Roof Tiles have been enhancing homes with proven strength and stylish designs. Combining classic appeal with modern durability, they offer unmatched protection and a fashionable finish to any home. Harvey Elite Plus® features a thicker steel substrate for the most challenging environments, while remaining light in weight to reduce load on roof structures.

Leakproof and weatherproof Harvey Elite Plus Roof Tiles not only look good, they reduce long-term maintenance and cost on your roof structure. Available in a variety of popular colors, Harvey Elite Plus Roof Tiles are built to last—resisting breakage, fading, and leaks, no matter what challenges the weather brings. Choose Harvey for a roof that combines style, strength, and reliability.



**Light in weight**

- Lightweight steel-based roof tiles
- Save on roof-structure timber costs
- Ideal for new roof or re-roofing old roofs



**Weatherproof**

- Gaps are eliminated
- Wind proof
- Hail proof
- Water and leakproof
- Minimised dust ingress
- No water absorption



**Low Maintenance**

- Avoid the inconvenience of fixing leaks
- Tiles do not need replacement



**Attractive**

- A range of stunning standard colours
- Double roman design for a unique roof appearance
- Ridge, cap and trim accessories for a professional finish



**Unbreakable**

- Unbreakable steel substrate
- Bonded stone granules protects against the elements
- No more broken roof tiles even in hailstorms



**Solar Compatible**

- Fixing brackets available
- A steel drill bit can easily be used for drilling holes for wiring / piping requirements



**Easy to Install**

- Easily installed on new roofs or over existing roof
- Engineered for effortless overlapping and fixing
- Lightweight for handling and on-site speed





# Harvey Thatch®

## The charm of thatch without the maintenance.

Harvey Thatch solves all the maintenance problems of natural thatch roofs but retains the African look you love. It is installed over a layer of natural thatch so you still enjoy the charm and insulation properties within your home.



### Lightning Safe

- Non-combustible and fire resistant
- No need for lightning conductor
- Standard earthing required



### Vermin, Bird & Pest Proof

- Water and airtight solution
- No access to the roof for vermin
- No need for unsightly chicken wire



### Fade Proof

- Natural, uncoated stone
- Unaffected by the sun's UV rays



### Lightweight

- Lightweight steel-based roof tiles
- Save on roof-structure timber costs
- Ideal for new roof or re-roofing old roofs



### Naturally Attractive

- A choice of 4 natural stone colours
- Shake Tile design for a thatch roof appearance
- Ridge, cap and trim accessories for a professional finish
- Use of natural stone as grit
- Beware of imitations that use coloured sand prone to fading.



### Never Paint

- Natural stone coat
- Never needs painting



### Low Maintenance

- Avoid the inconvenience of leaks
- Eliminates the need for thatch combing
- Never re-thatch



### Unbreakable

- Unbreakable steel substrate
- Bonded stone granules protects against the elements
- No broken roof tiles



### Solar Compatible

- Fixing brackets available



### Weatherproof

- Gaps are eliminated
- Wind proof
- Hail resistant
- Water and leakproof
- No dust ingress
- No water absorption



### Easy to Install

- Easily installed on new roofs or over an existing roof
- Engineered for effortless overlapping and fixing
- Lightweight for handling and on-site speed



### 20 Year Warranty

- Excellent functional benefits including a 20 year Product Warranty (Terms & Conditions apply).





Harvey Thatch® Midnight Black



Harvey Thatch® Dark

## Re-roofing with Harvey Thatch®



Before



After



Before



After



CSIR FireLab Test

## Superior Fire Resistance

Natural thatch poses a significant fire risk to owners and occupants. Harvey Thatch gives you complete peace of mind as fire risk is reduced to a minimum. Harvey Thatch is certified with an 'A' Fire Rating, the highest roof material fire resistance as tested to SANS 10177-12 standard\*.

\*When installed to specification



## Effects of lightning

Lightning will generally strike the highest object in an area, regardless of the material from which it is made. Harvey Thatch does not create nor attract lightning and if struck, is non-combustible. One does not require a lightning pole, however the roof should be earthed like all metal roofs. All wiring should be insulated.



# Harvey Steel-based Tile Accessories



## 1 Angle Ridge

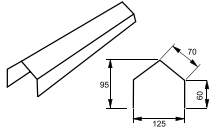

Fixed to double batten at apex  
Length: 1720mm (cover 1600mm)  
Width: 125mm tapered lengthwise  
Height: 95mm  
Mass: 2.5kg

## 2 Angle Ridge End Cap

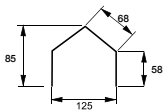

Fixed to end of Angle Ridge  
Width: 125mm  
Height: 90mm

## 3 Angle Hip Cap

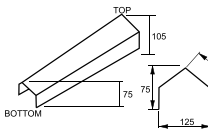

Fixed to double batten at hip battens  
Length: 580mm (cover 1 per tile course)  
Width: 125mm tapered down to 123mm  
Height: 75mm tapered up to 105mm  
Mass: 0.8kg

## 4 Angle Hip End Cap

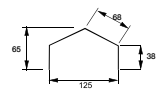

Fixed to end of Angle Hip  
Width: 125mm  
Height: 70mm

## 5 Square Ridge (Elite only)

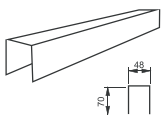

Fixed to double batten at apex  
Length: 1720mm (cover 1600mm)  
Width: 48mm tapered lengthwise  
Height: 70mm  
Mass: 1.8kg

## 6 Square Hip Cap (Elite only)

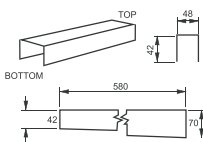

Fixed to single hip batten  
Length: 580mm (cover 1 per tile course)  
Width: 48mm tapered down to 45mm  
Height: 42mm tapered up  
Mass: 0.5kg

## 7 Bargeboard Cover

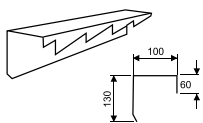

Left and right hand serrated. Fixed to barge boards at gable ends. Sketch shows right handed barge board cover.  
Length: 1550mm Height: 130mm  
Cover 4 tile courses  
Mass: 2.3kg

## 8 Sidewall Flashing

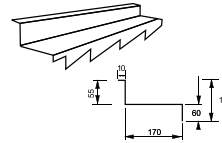

Left and right hand serrated. Sketch shows right handed sidewall.  
Length: 1550mm Height: 115mm  
Cover 4 tile courses  
Width: 170mm Upper Lip: 10mm

## 9 Cover Flashing

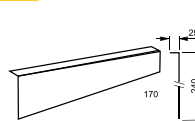

For use at headwall and sidewall flashing as well as for short courses at ridge.  
Length: 1720mm Width: 240mm  
Upper Lip: 25mm Cover: 1600mm  
Mass: 2.5 kg

## 10 Gable Trim (Elite only)

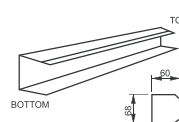

Fixed to gable ends  
Length: 1720mm (cover 1600mm)  
Width: 60mm  
Height: 68mm tapered up  
Mass: 1.8kg

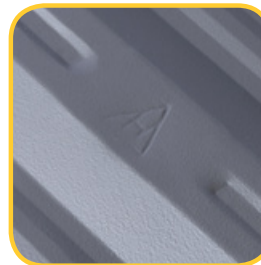

Harvey Elite



Harvey Thatch

## The Harvey Quality Stamp

### Beware of inferior imitations.

We take great care to ensure that every Harveytile is manufactured to the most stringent quality standards. As a division of Africa's leading steel supplier, Macsteel, we have access to the best steel. We prepare and press the Zinc or Alu-Zinc coated steel to the finest tolerances, cover the tile with natural stone coatings and finally achieve the tile with the best appearance.

Once complete, we take care to quality check each tile so as to ensure that it meets our quality standards. Only then do we place our Harvey Quality Stamp on each tile.

This means you can rest assured that if the tile carries the Harveytile Quality Stamp, that it's a Harveytile manufactured to the most exacting standards. Look for the Harveytile Quality Stamp.

**"If it doesn't say Harveytile, its not a Harveytile"**





# Protecting the Environment. Protecting your home.

## Mineral Polymer Composite Roof Tiles

### Lightweight, strong and beautiful roof tiles

Harvey EcoTile® is an innovative roofing solution crafted from 97% waste materials, setting a new standard for sustainable construction. Combining strength, beauty and eco-conscious design, these Mineral Polymer Composite Roof Tiles are transforming the industry, one roof at a time.

### What Makes Harvey EcoTile® Unique?

Made from a cutting-edge blend of recycled polyolefin and waste minerals, EcoTile® offers a host of advantages:

### Shatterproof and Resilient

With strength levels four times greater than traditional concrete tiles, EcoTile® eliminates concerns about brittleness.

### A Lighter Load

Weighing 70% less than comparable concrete tiles, these lightweight tiles simplify installation without sacrificing durability. The reduced weight greatly reduces transport costs and the need for costly weight bearing roof trusses.

### Strength Meets Style

Harvey EcoTile® is engineered for exceptional performance. Its innovative material composition and precise fixing methodology create a roof that's virtually impenetrable to weather. The result? Symmetrical, seamless lines that deliver superior weatherproofing and eliminate gaps, ensuring your roof is not only water- and dust-proof but also visually stunning.



Solar Bracket

- Stylish Double Roman design combines exceptional functional advantages with classic aesthetics.
- Advanced engineering provides a system for weather proofing and superior strength.
- Precision-fit accessories provides weatherproof, maintenance-free seal.
- Non-porous, non-brittle finish ensures low water absorption and light weight in all weather conditions.





# Future-Proof Roofing



## Lightweight

- 70% lighter than comparable concrete tiles
- Save on roof-structure timber costs
- Transport 3 times more roof tiles with one load
- Easy offload and handling on-site



## Low Maintenance

- UV stability
- Ridge Tile assembly does not require unsightly cement and debris
- No need to repaint your roof
- Will not shift due to fixing methodology



## Strong & Durable

- 4x stronger than standard concrete tiles
- Virtually unbreakable in normal use
- Shatterproof
- Walkable once installed
- Enhanced security
- Non-brittle
- Save up to 10% on breakages vs. concrete tiles



## Weatherproof

- Precision engineered design
- Gaps are eliminated
- Wind proof beyond gale force
- Hail proof
- Water and leakproof
- Minimised dust ingress
- Low water absorption



## Attractive design

- Classic Double Roman design
- Creates a precise and uniform complete structure
- Consistent matte black textured surface
- Through-colour (not coated)



## Easy installation

- 5 Location points for ease of placement
- Fixing screw ensures quick fastening and suitable for high wind areas
- On-site speed due to light weight
- "Cuts like butter" with no dust unlike concrete tiles



## Paintable

- Standard matte marbled charcoal coloured tile
- No need to paint
- Paintable with Harvey Products approved paint in any colour desired post construction



## SANS 10400-T Tested

- Harvey Eco Tile is tested in Accordance to SANS -10177 - 123 and conforms to SANS 10400-T with regards to safety distance
- Agrément certification ref: 2021/624



## Solar Compatible

- Fixing brackets available
- A masonry drill bit can easily be used for drilling holes for wiring / piping requirements



## Re-roofing

- Suitable for re-roofing over an existing roof
- No disruption to occupants, tenants or business activity



## Waste Material

- Manufactured from mineral waste products
- Each tile removes the equivalent of 3.8 two-litre milk bottles from the environment



## 100% Recyclable

- Harvey EcoTile® is manufactured from 100% recyclable waste material



## Waterless Production

- No water is required in the manufacturing of Harvey EcoTile®
- Zero water content in finished product



## Community Development

- Materials are sourced from local community projects
- Production stimulates primary and secondary job creation

## Technical Specifications

**Tile weight (ave): 1.6kg each**  
**Tiles per m<sup>2</sup>: 9.6**  
**Weight per m<sup>2</sup>: 15.36kg**

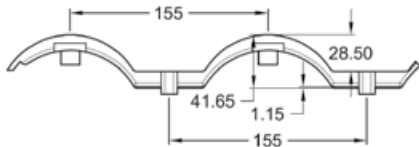

Wall thickness: 4.5mm  
 Overall thickness: 12mm

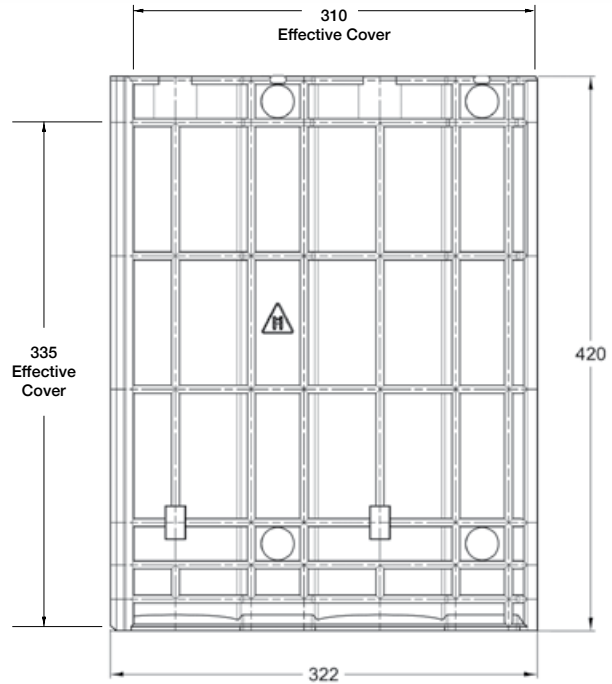

## Accessories

### Ridge Cap

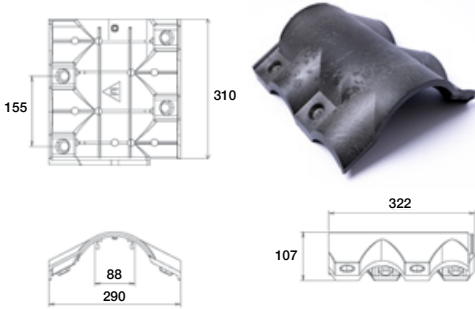

Weight: 1.6kg each

### Hip Cap

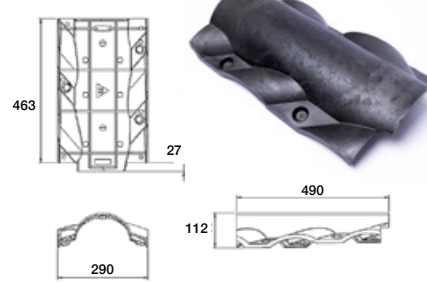

### Hip Starter

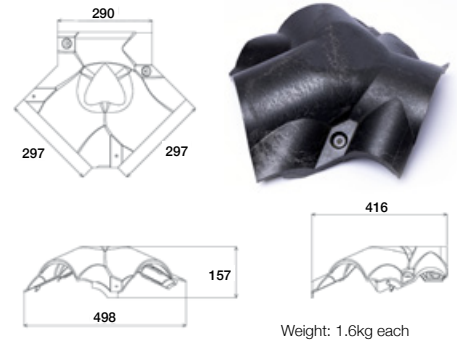

Weight: 1.6kg each

### Hip End Cap

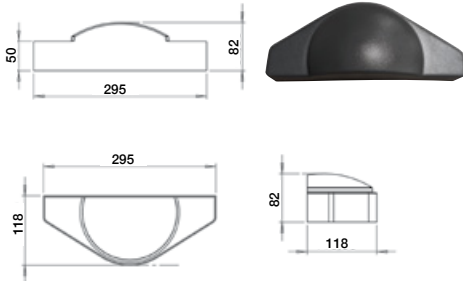

### Fastening Accessories

Self Drilling screw #10 (4.8mm) x 45mm Hex Washer Head T17 CL3 + #10 x 16mm Bonded Washer with Seal



### Solar Bracket



### Harvey Roofing Products

A Division of Macsteel Service Centres SA (Pty) Ltd.  
 Tel: +27 11 741 5600  
 info@harveyroofingproducts.co.za  
 www.harveyroofingproducts.co.za

